



PROGETTO ESECUTIVO

Appalto integrato sulla base del progetto di fattibilità tecnica ed economica "Smart City Napoli Nord - Piani Urbani Integrati – M5C2 – I.2.2"

CIG 972663946C CUP I45I22000020006 - CUP I45I22000030006

RTI

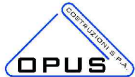

OPUS COSTRUZIONI S.P.A.

Capogruppo

P.IVA 07201350639

Via Campana 233, Pozzuoli



ARCHIVOLTO SRL

Mandante

P.IVA 07162480631

Via O. P. Cafaro n.4, Napoli

RTP

SAG ARCHITETTURA SRLS

P.IVA 09189081210

Sede legale: Via Posillipo 66, Napoli

MASCOLO INGEGNERIA SRL

P.IVA 08524811216

Sede legale: Via Gramsci 19, Cicciano

ELECTA SRL

P.IVA 04082971211

Sede legale: Via Principe di Piemonte 109, Roccarainola

RUP

Arch. Pasquale Imbema

PROGETTO ELETTRICO - (Casavatore Piazza Immacolata)
Capitolato Speciale - Parte Tecnica - Progetto
impianto fotovoltaico_Pensilina e Stazionamento

DATA EMISS.	Aprile 2024		CODIFICA	CSV.PE.ELT.R.	004_01
SCALA	-	FORMATO			

REVISIONE	DESCRIZIONE	DATA	APPROVATO DA
01	Integrazione rapporto di validazione	Giugno 2024	
00	prima emissione	Aprile 2024	



HiKu6 Mono PERC

535 W ~ 555 W

CS6W-530 | 535 | 540 | 545 | **550** | 555MS

MORE POWER



Module power up to 555 W
Module efficiency up to 21.5 %



Up to 4.5 % lower LCOE
Up to 5.6 % lower system cost



Comprehensive LID / LeTID mitigation technology, up to 50% lower degradation



Compatible with mainstream trackers, cost effective product for utility power plant



Better shading tolerance

MORE RELIABLE



Minimizes micro-crack impacts



Heavy snow load up to 5400 Pa, wind load up to 2400 Pa*



Enhanced Product Warranty on Materials and Workmanship*



Linear Power Performance Warranty*

**1st year power degradation no more than 2%
Subsequent annual power degradation no more than 0.55%**

*According to the applicable Canadian Solar Limited Warranty Statement.

MANAGEMENT SYSTEM CERTIFICATES*

ISO 9001:2015 / Quality management system
ISO 14001:2015 / Standards for environmental management system
ISO 45001: 2018 / International standards for occupational health & safety
IEC62941: 2019 / Photovoltaic module manufacturing quality system

PRODUCT CERTIFICATES*

IEC 61215 / IEC 61730 / CE
UL 61730 / IEC 61701 / IEC 62716 / Take-e-way



* The specific certificates applicable to different module types and markets will vary, and therefore not all of the certifications listed herein will simultaneously apply to the products you order or use. Please contact your local Canadian Solar sales representative to confirm the specific certificates available for your Product and applicable in the regions in which the products will be used.

CSI Solar Co., Ltd. is committed to providing high quality solar photovoltaic modules, solar energy and battery storage solutions to customers. The company was recognized as the No. 1 module supplier for quality and performance/price ratio in the IHS Module Customer Insight Survey. Over the past 22 years, it has successfully delivered over 88 GW of premium-quality solar modules across the world.

* For detailed information, please refer to the Installation Manual.

ENGINEERING DRAWING (mm)

Rear View

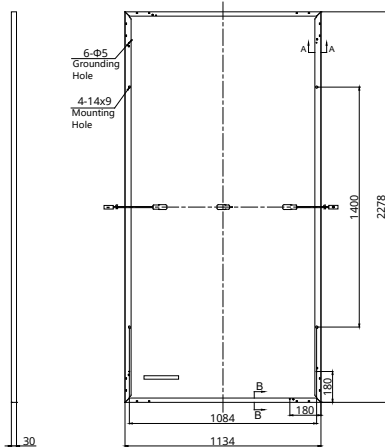

Frame Cross Section

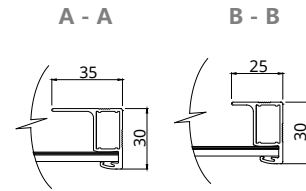

Mounting Hole

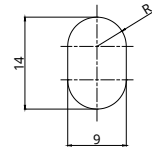

CS6W-530MS / I-V CURVES

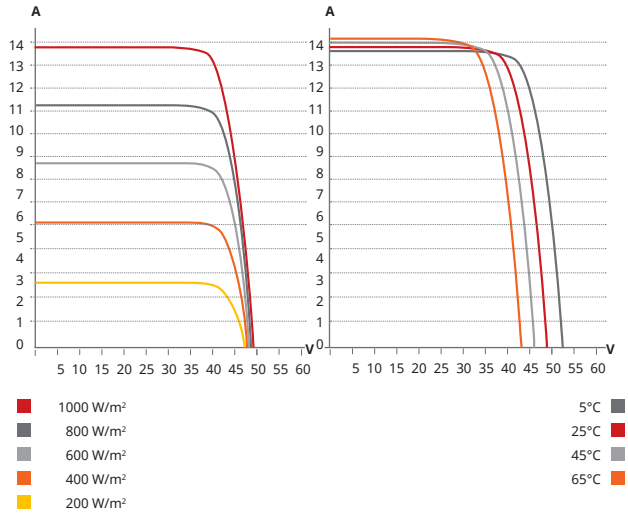

ELECTRICAL DATA | STC*

CS6W	530MS	535MS	540MS	545MS	550MS	555MS
Nominal Max. Power (Pmax)	530 W	535 W	540 W	545 W	550 W	555 W
Opt. Operating Voltage (Vmp)	40.9 V	41.1 V	41.3 V	41.5 V	41.7 V	41.9 V
Opt. Operating Current (Imp)	12.96 A	13.02 A	13.08 A	13.14 A	13.20 A	13.25 A
Open Circuit Voltage (Voc)	48.8 V	49.0 V	49.2 V	49.4 V	49.6 V	49.8 V
Short Circuit Current (Isc)	13.80 A	13.85 A	13.90 A	13.95 A	14.00 A	14.05 A
Module Efficiency	20.5%	20.7%	20.9%	21.1%	21.3%	21.5%
Operating Temperature	-40°C ~ +85°C					
Max. System Voltage	1500V (IEC/UL) or 1000V (IEC/UL)					
Module Fire Performance	TYPE 1 (UL 61730 1500V) or TYPE 2 (UL 61730 1000V) or CLASS C (IEC 61730)					
Max. Series Fuse Rating	25 A					
Application Classification	Class A					
Power Tolerance	0 ~ + 10 W					

* Under Standard Test Conditions (STC) of irradiance of 1000 W/m², spectrum AM 1.5 and cell temperature of 25°C.

ELECTRICAL DATA | NMOT*

CS6W	530MS	535MS	540MS	545MS	550MS	555MS
Nominal Max. Power (Pmax)	397 W	401 W	405 W	409 W	412 W	416 W
Opt. Operating Voltage (Vmp)	38.3 V	38.5 V	38.7 V	38.9 V	39.1 V	39.3 V
Opt. Operating Current (Imp)	10.38 A	10.42 A	10.47 A	10.52 A	10.55 A	10.59 A
Open Circuit Voltage (Voc)	46.1 V	46.3 V	46.5 V	46.7 V	46.9 V	47.1 V
Short Circuit Current (Isc)	11.13 A	11.17 A	11.21 A	11.25 A	11.29 A	11.33 A

* Under Nominal Module Operating Temperature (NMOT), irradiance of 800 W/m² spectrum AM 1.5, ambient temperature 20°C, wind speed 1 m/s.

* The specifications and key features contained in this datasheet may deviate slightly from our actual products due to the on-going innovation and product enhancement. CSI Solar Co., Ltd. reserves the right to make necessary adjustment to the information described herein at any time without further notice.

Please be kindly advised that PV modules should be handled and installed by qualified people who have professional skills and please carefully read the safety and installation instructions before using our PV modules.

MECHANICAL DATA

Specification	Data
Cell Type	Mono-crystalline
Cell Arrangement	144 [2 x (12 x 6)]
Dimensions	2278 x 1134 x 30 mm (89.7 x 44.6 x 1.18 in)
Weight	27.6 kg (60.8 lbs)
Front Cover	3.2 mm tempered glass with anti-reflective coating
Frame	Anodized aluminium alloy
J-Box	IP68, 3 bypass diodes
Cable	4 mm ² (IEC), 12 AWG (UL)
Cable Length (Including Connector)	350 mm (13.8 in) (+) / 250 mm (9.8 in) (-) or customized length*
Connector	T6 or MC4-EVO2 or MC4-EVO2A
Per Pallet	35 pieces
Per Container (40' HQ)	700 pieces or 630 pieces (only for US & Canada)

* For detailed information, please contact your local Canadian Solar sales and technical representatives.

TEMPERATURE CHARACTERISTICS

Specification	Data
Temperature Coefficient (Pmax)	-0.34 % / °C
Temperature Coefficient (Voc)	-0.26 % / °C
Temperature Coefficient (Isc)	0.05 % / °C
Nominal Module Operating Temperature	41 ± 3°C

PARTNER SECTION



CSI Solar Co., Ltd.

199 Lushan Road, SND, Suzhou, Jiangsu, China, 215129, www.csisolar.com, support@csisolar.com

ELEGANTE 200-210 W

Premium PV Panel

Solar safety glass.

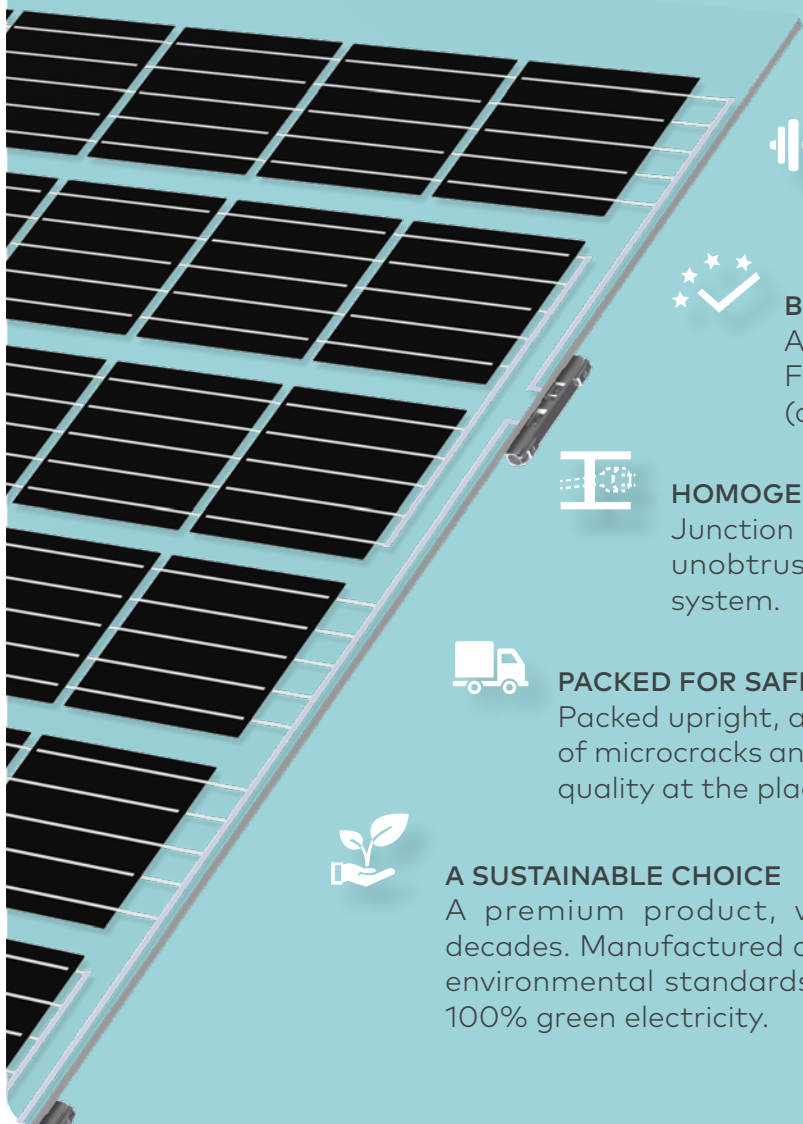

TRANSPARENCY ~28%
The perfect balance of light and shadow.



ROBUST
Strong construction -
2 x 4 mm partially tempered glass.



BUILDING PRODUCT
According to guideline DIN 18008.
For vertical and overhead glazing
(abZ of DIBt Z-70.3-232).



HOMOGENEOUS OPTICS
Junction boxes can be installed
unobtrusively in the mounting
system.



PACKED FOR SAFE TRANSPORT
Packed upright, avoiding the emergence
of microcracks and thus ensuring factory
quality at the place of delivery.



A SUSTAINABLE CHOICE
A premium product, which lasts for
decades. Manufactured according to rigid
environmental standards. Produced with
100% green electricity.

MADE IN GERMANY!

Right here. In Prenzlau. In our production facility.
Here we manufacture under the aspects of
quality & durability since 2001.

FULL SERENITY



30 Years linear
Power Guarantee



30 Years
Product Warranty

100% cost recovery of guarantee claims.

Under the terms and conditions of the respective guarantee certificate.

QUALITY UNDER HAND AND SEAL

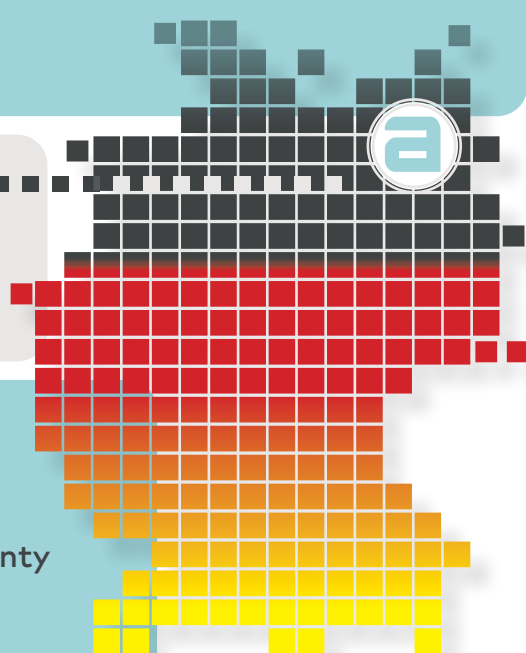

aleo solar PV-safety glass Elegante

ELECTRICAL DATA (STC)		G40C200	G40C210
Rated power	P_{MPP} [W]	200	210
Rated voltage	V_{MPP} [V]	21.7	22.3
Rated current	I_{MPP} [A]	9.22	9.42
Open-circuit voltage	V_{OC} [V]	26.8	27.1
Short-circuit current	I_{SC} [A]	9.71	9.91
Efficiency	η [%]	13.2	13.8

Electrical values measured under standard test conditions (STC): 1000 W/m²; 25°C; AM 1.5

BASIC DATA	
Length x width x height	[mm] 950 x 1600 x 9 (12.5 mm height junction box)
Weight	[kg] 31.5
Number of cells	40
Cell size	[mm] 158.75 x 158.75
Cell material	Monocrystalline Si, PERC,
Number of bus bars	5
Front glass	4.0 mm Solar glass (TSG)
Back glass	4.0 mm Solar glass (TSG)

BASIC DATA JUNCTION BOX	
Length x width x height	[mm] 105.8 x 15.5 x 12.5
IP class	IP67
Cable length	[mm] 820
Connectors	TE Slim Line
Bypass diodes	2 (one per junction box)

LOADS	
Max. pressure load	[Pa] 7500*
Max. suction load	[Pa] 5400*
Max. system voltage	[V _{DC}] 1000
Reverse current load	I_R [A] 20
Mechanical load acc. to IEC/EN 61215	
* Please observe the mounting conditions in the installation manual	

TEMPERATURE COEFFICIENTS	
Temperature coefficient I_{SC}	$\alpha(I_{SC})$ [%/K] +0.05
Temperature coefficient V_{OC}	$\beta(V_{OC})$ [%/K] -0.29
Temperature coefficient P_{MPP}	$\gamma(P_{MPP})$ [%/K] -0.40

Measurement tolerance of P_{MPP} under STC -3/+3% | Accuracy of other electrical values -10/+10%
Efficiency relating to gross PV-safety glass area

ADDITIONAL ELECTRICAL DATA	
Reduction of STC efficiency from 1000 W/m ² to 200 W/m ²	[%] rel. < 2
Classification range (positive classification)	[W] 0/+9.99



The regulations of laminated safety glass according to DIN 18008 apply to the planning, dimensioning and execution of the glazing.

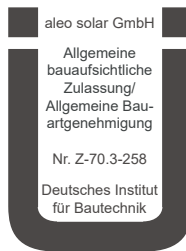

CERTIFICATIONS AND WARRANTY	
Product Guarantee	30 years
Power Guarantee	30 years
Fire Resistance	Class A according to IEC 61730-2
Protection Against Electric Shock	II
Certifications	architectural certification from DIBt

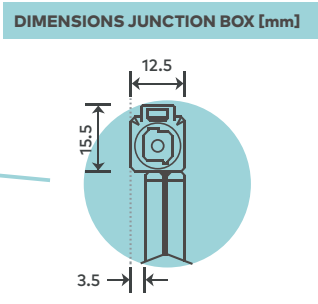
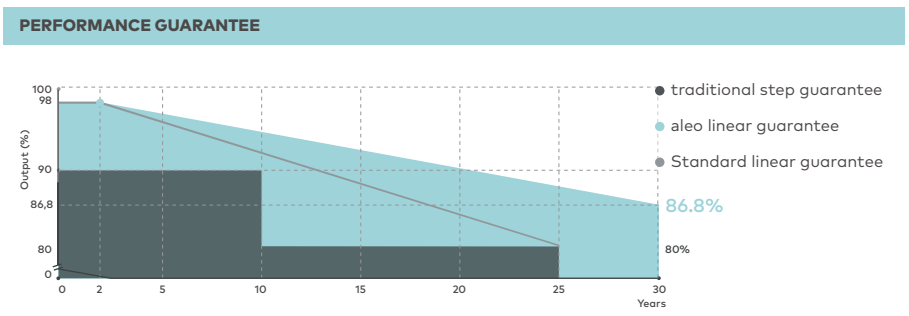
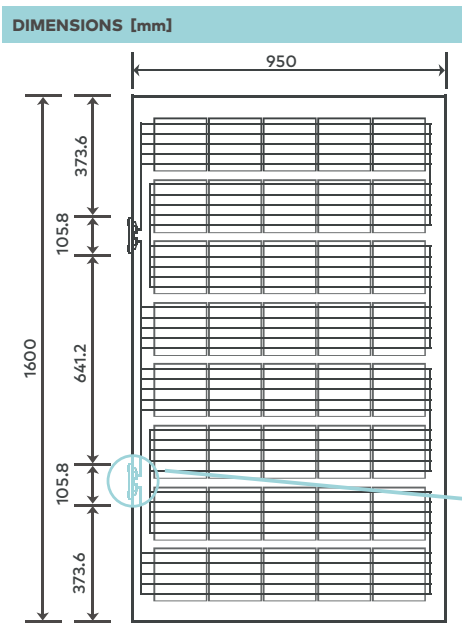

PLEASE CONTACT YOUR AUTHORISED ALEO DEALER

ALEO SOLAR GMBH

Marius-Eriksen-Straße 1
17291 PRENZLAU
GERMANY

CONTACT

+49 3984-8328-0
info@aleo-solar.com
www.aleo-solar.com



Hybrid Inverter

SUN-5/6/7.6/8K-SG02LP1-EU-AM2

SUN-10/12K-SG02LP1-EU-AM3



Colorful touch LCD, IP65 protection degree



AC couple to retrofit existing solar system

16

Max. 16 pcs parallel for on-grid and off-grid operation; Support multiple batteries parallel

250

Max. charging/discharging current of 250A

6

6 time periods for battery charging/discharging



Support storing energy from diesel generator

Technical Data

Model	SUN-5K-SG02 LP1-EU-AM2	SUN-6K-SG02 LP1-EU-AM2	SUN-7.6K-SG02 LP1-EU-AM2	SUN-8K-SG02 LP1-EU-AM2	SUN-10K-SG02 LP1-EU-AM3	SUN-12K-SG02 LP1-EU-AM3
Battery Input Data						
Battery Type	Lead-acid or Lithium-ion					
Battery Voltage Range (V)	40-60					
Max. Charging Current (A)	120	135	190	190	220	250
Max. Discharging Current (A)	120	135	190	190	220	250
External Temperature Sensor	Yes					
Charging Curve	3 Stages / Equalization					
Charging Strategy for Li-Ion Battery	Self-adaption to BMS					
PV String Input Data						
Max. DC Input Power (W)	6500	7800	9880	10400	13000	15600
Rated PV Input Voltage (V)	370 (125-500)					
Start-up Voltage (V)	125					
MPPT Voltage Range (V)	150-425					
Full Load DC Voltage Range (V)	300-425	200-425				
PV Input Current (A)	13+13	26+13	26+26	26+26	26+26+26	26+26+26
Max. PV I _{SC} (A)	22+22	44+22	44+44	44+44	44+44+44	44+44+44
No. of MPP Trackers	2				3	
No. of Strings per MPP Tracker	1+1	2+1	2+2	2+2	2+2+2	2+2+2
AC Output Data						
Rated AC Output Active Power (W)	5000	6000	7600	8000	10000	12000
Max AC Output Active Power (W)	5500	6600	8360	8800	11000	13200
AC Output Rated Current (A)	22.8/21.8	27.3/26.1	34.6/33.1	36.4/34.8	45.5/43.5	54.6/52.2
Max AC Output Current (A)	25/24	30/28.7	38/36.4	40/38.3	50/47.9	60/57.4
Max. Continuous AC Passthrough (A)	35	40	50	50	70	70
Peak Power (off grid)	2 time of rated power, 10 S					
Power Factor Adjustment Range	0.8 leading to 0.8 lagging					
Power Factor	1					
Output Frequency and Voltage	50 / 60Hz; L/N/PE 220/230Vac					
Grid Type	Split Phase; 2/3 phase; Single Phase					
Total Harmonic Distortion (THD)	<3% (of nominal power)					
DC Current Injection	<0.5% I _n					
Efficiency						
Max. Efficiency	97.60%					
Euro Efficiency	97.00%					
MPPT Efficiency	99.90%					
Protection						
Integrated	Anti-islanding Protection, PV String Input Reverse Polarity Protection, Insulation Resistor Detection, Residual Current Monitoring Unit, Output Over Current Protection, Output Shorted Protection, Surge Protection					
Over Voltage Category	DC Type II/AC Type III					
Certifications and Standards						
Grid Regulation	VDE4105, IEC61727/62116, VDE0126, AS4777.2, CEI 0 21, EN50549-1, G98, G99, C10-11, UNE217002, NBR16149/NBR16150					
Safety EMC / Standard	IEC/EN 61000-6-1/2/3/4, IEC/EN 62109-1, IEC/EN 62109-2					
General Data						
Operating Temperature Range (°C)	-40-60°C, >45°C Derating					
Cooling	Smart Cooling					
Noise (dB)	≤30 dB					
Communication with BMS	RS485; CAN					
Weight (kg)	32					
Cabinet Size (WxHxD mm)	420×670×233 (Excluding Connectors and Brackets)					
Protection Degree	IP65					
Installation Style	Wall-mounted					
Warranty	5 Years (10 Years Optional)					

RW-M6.1-B

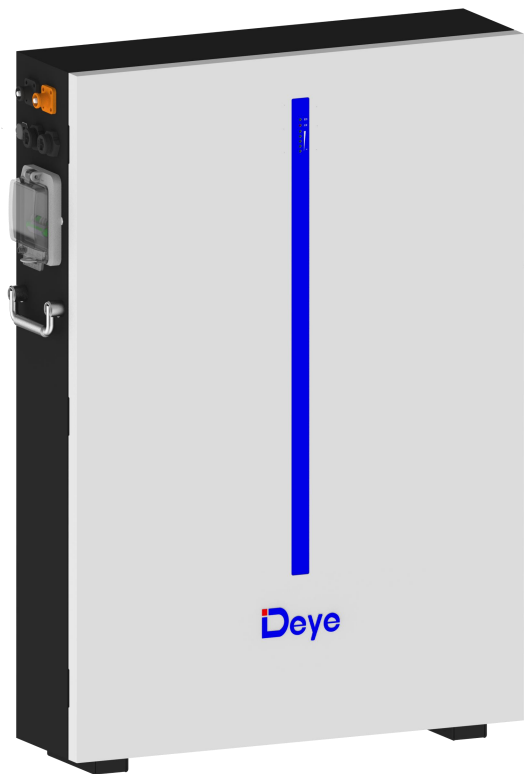

◆ Safer

Cobalt Free Lithium Iron Phosphate (LFP) Battery, safety and long lifespan, high efficiency and high-power density. Intelligent BMS, providing complete protection.

◆ Reliable

Support high discharge power. IP65, natural cooling, wide temperature range: -20°C to 55°C.

◆ Flexible

Modular design, easy to expand, Max. 32 units in parallel, Max. capacity of 196kWh. Suited to residential and commercial applications for increasing the self-consumption ratio.

◆ Convenient

Battery module auto networking, easy maintenance, remotely monitoring and upgrade, support USB drive upgrade the firmware.

◆ Eco-Friendly

Use environmental protection materials, the whole module non-toxic, pollution-free.

◆ Wall-Mounted & Floor-Mounted

Flat design, support wall-mounted and floor-mounted, saving installation space.

Model		RW-M6.1-B
Main Parameter		
Battery Chemistry	LiFePO4	
Capacity (Ah)	120	
Scalability	Max.32 pcs in Parallel(196kWh)	
Nominal Voltage (V)	51.2	
Operating Voltage(V)	43.2~57.6	
Energy (kWh)	6.14	
Usable Energy (kWh) ^[1]	5.53	
Rated DC Power(kW)	3.07	
Charge/Discharge Current (A) ^[2]	Recommend	60
	Max.	100
	Peak(2mins,25°C)	150
Other Parameter		
Recommend Depth of Discharge	90%	
Dimension (W/H/D, mm)	510*740*145(Without Base, depth of 161mm with Hanging Board)	
Weight Approximate(kg)	58	
Master LED Indicator	5LED(SOC:20%~SOC100%),3LED (working, alarming, protecting)	
IP Rating of Enclosure	IP65	
Operating Temperature	Charge:0~55°C / Discharge:-20°C~55°C	
Storage Temperature	0°C~35°C	
Humidity	5%~95%	
Altitude	≤2000m	
Cycle Life	≥6000(25°C±2°C,0.5C/0.5C,70%EOL)	
Installation	Wall-Mounted, Floor-Mounted	
Communication Port	CAN2.0, RS485	
Warranty Period ^[3]	10 years	
Energy Throughput	20MWh@70%EOL	
Certification	UN38.3, IEC62619, CE, CEI 0-21, VDE2510-50	

[1] DC Usable Energy, test conditions: 90% DOD, 0.5C charge & discharge at 25°C. System usable energy may vary due to system configuration parameters.

[2] The current is affected by temperature and SOC.

[3] Conditions apply, refer to Deye Warranty Letter.

[4] Made in China.

Introduction

This series lithium iron phosphate battery is one of new energy storage products developed and produced by Deye , it can be used to support reliable power for various types of equipment and systems.

This series is especially suitable for application scene of high power, limited installation space, restricted load-bearing and long cycle life.

This series has built-in BMS battery management system, which can manage and monitor cells information including voltage, current and temperature. What's more, BMS can balance cells charging to extend cycle life.

Multiple batteries can connect in parallel for larger capacity and longer power supporting duration.

Model	Accessories Parts Description	Remark
RW-M6.1-B-Hboard	Battery Hanging Board (Included)	Used for battery fixing on the wall
RW-M6.1-B-PCable	Hybrid inverter Cable (Included)	Battery power and communication cable connect with hybrid inverter
RW-M6.1-B-BCable	Battery Parallel Cable (Included)	Battery power and communication parallel connection cable
RW-M6.1-B-Fixed support	Fixed supports (Included)	When floor-mounted, fixing the battery to the wall

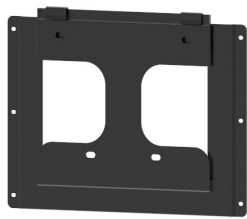

Model: RW-M6.1-B-Hboard

Details: 3kg(Appr.)

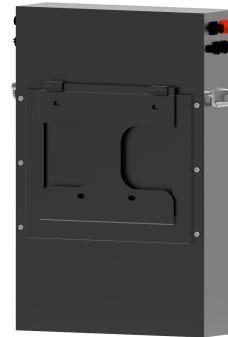

Model: RW-M6.1-B-PCable1500

Details: Pair of 2/0AWG DC power cable (one end has a waterproof terminal, the other end is M10 copper terminal) and RJ45 communication cable connect with hybrid inverter (one end has a waterproof terminal) .The default length is 1500mm.



Model: RW-M6.1-B-BCable300

Details: Pair of 2/0AWG Battery power cable and RJ45 communication cable for battery parallel, **both ends have waterproof terminals**. The default length is 300mm.

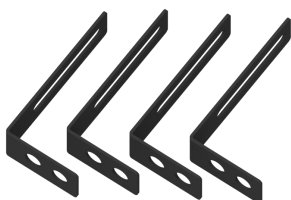

Model: RW-M6.1-B-Fixed support

Details: When floor-mounted, use these fixed supports to fixing the battery to the wall.

Scheda Tecnica N° WPSIT0096.b

Annulla e sostituisce WPSIT0096.a

DESCRIZIONE

Membrana sintetica realizzata in poliolefina modificata TPO, ottenuta per co-estrusione con inserimento di rete di poliestere. Il compound contiene speciali pigmenti che per tutto lo spessore conferiscono alla membrana una colorazione bianca ed un elevato indice di riflettanza solare. Inoltre la membrana è caratterizzata da una altissima resistenza ad agenti atmosferici e raggi U.V.

Prodotto in stabilimento certificato UNI EN ISO 9001 (sistema di qualità aziendale) e UNI EN ISO 14001 (sistema ambientale).

Posa in opera da parte di installatori approvati da Soprema srl. Finiture ed accessori con elementi prodotti ed approvati da Soprema srl.

CARATTERISTICHE

- Resistenza ad agenti atmosferici e raggi U.V.
- Resistenza alle sollecitazioni causate dal vento
- Imputrescibilità
- Resistenza meccanica ed al punzonamento
- Adattabilità ai movimenti strutturali
- Buona flessibilità alle basse temperature

AREA DI UTILIZZO

COPERTURE

- A vista, a fissaggio meccanico
- Coperture ad elevato SRI (Cool Roof Effect)

	EP/PR SC 1,50 ENERGY PLUS	EP/PR SC 1,80 ENERGY PLUS	EP/PR SC 2,00 ENERGY PLUS	Metodo di prova
Indice riflettanza solare (SRI)	90	90	90	ASTM E 1980

Test eseguiti presso Dip. di Ingegneria Meccanica e Civile / EELab (Energy Efficiency Laboratory) – Università di Modena e Reggio Emilia

CARATTERISTICHE

		EP/PR SC 1,50 ENERGY PLUS	EP/PR SC 1,80 ENERGY PLUS	EP/PR SC 2,00 ENERGY PLUS	Metodo di prova
Spessore (mm)		1,50	1,80	2,00	UNI EN 1849-2
Peso (kg/m ²)		1,90	2,28	2,54	UNI EN 1849-2
Carico a rottura (N/5cm)		≥ 1100	≥ 1100	≥ 1100	UNI EN 12311-2
Allungamento a rottura (%)		≥ 15	≥ 15	≥ 15	UNI EN 12311-2
Resistenza alla lacerazione (N)		≥ 300	≥ 300	≥ 300	UNI EN 12310-2
Resistenza all'impatto (mm)		≥ 800	≥ 900	≥ 1250	UNI EN 12691
Piegatura a freddo (°C)		≤ - 25	≤ - 25	≤ - 25	UNI EN 495-5
Resistenza alla pressione idrostatica (6 h a 0,5 Mpa)		nessuna perdita	nessuna perdita	nessuna perdita	UNI EN 1928 met. B
Stabilità dimensionale (%)		≤ 0,5	≤ 0,5	≤ 0,5	UNI EN 1107-2
Resistenza all'invecchiamento accelerato (U.V.)		nessuna fessurazione	nessuna fessurazione	nessuna fessurazione	UNI EN 1297
Resistenza al punzonamento statico (kg)		≥ 20	≥ 20	≥ 20	UNI EN 12730
Classificazione al fuoco*	(classe)	B roof t2 B roof t3	B roof t2 B roof t3	B roof t2 B roof t3	ENV 1187 e EN 13501-5
Classe di reazione al fuoco	(classe)	E	E	E	EN ISO 11925-2 e EN 13501-1

* Classificazione valida esclusivamente per l'applicazione del manto per sistemi indicati come da certificazione disponibile su richiesta.

STANDARD DI PRODUZIONE

Spessore	1,50 mm		1,80 mm		2,00 mm	
	1,05 m	2,10 m	1,05 m	2,10 m	1,05 m	2,10 m
Larghezza						
Numero rotoli per pallet	23	14	18	14	18	14
Lunghezza	20 m		20 m		20 m	
Colore (superficie / fondo)	BIANCO					

MARCHIO CE

Codice di identificazione unico del prodotto tipo: WPSIT0096

Le membrane FLAGON EP/PR SC Energy Plus sono prodotte nell'azienda SOPREMA srl di Chignolo d'Isola (Italia) e sono oggetto del marchio CE in conformità a EN 13956:2012 certificato n°1085-CPR-011.

Il manto per la sua formulazione NON è soggetto agli obblighi del Regolamento CLP (CE) n° 1272/2008 e UE n° 487/2013 e s.m.i sulle sostanze pericolose. Nel caso in cui il prodotto debba essere smaltito come rifiuto, si consiglia l'invio in discarica autorizzata o in un inceneritore dotato di camera di postcombustione e lavaggio dei fumi.

I dati indicati nella presente scheda, all'esclusione di quelli richiesti dalla marchiatura CE, non sono tassativi e SOPREMA srl può, senza particolare segnalazione, modificarli. SOPREMA srl si riserva il diritto di apportare in ogni momento e senza preavviso modifiche di qualsivoglia natura, nonché di cessarne la produzione. SOPREMA srl si riserva il diritto, in base all'evoluzione delle conoscenze e delle tecniche, di modificare senza preavviso la composizione e le condizioni di impiego dei suoi materiali e, di conseguenza, i relativi prezzi. Un ordine, pertanto, verrà ritenuto accettato unicamente alle condizioni e alle specifiche tecniche in vigore il giorno della sua ricezione.